

DURCHFÜHRUNG FÜR ALUMINIUMROLLLADEN

 = 4 Kant / 8 mm / Länge 500 mm (ohne Schrauben geliefert)

BIEGBAR DURCHFÜHRUNG INOX

Senkschrauben 4x20 mm Art. 16VISPA4/20 

N°13

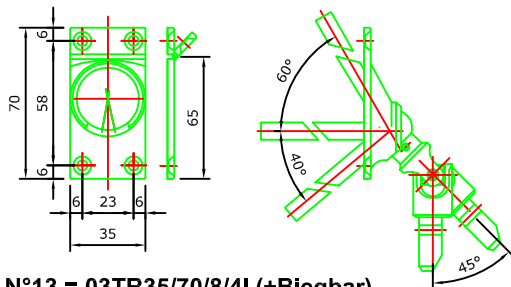

N°13 = 03TR35/70/8/4I (+Biegbar)

DURCHFÜHRUNG ZAMAC 90°

Senkschrauben 4x20 mm Art. 16VISPA4/20 

N°14

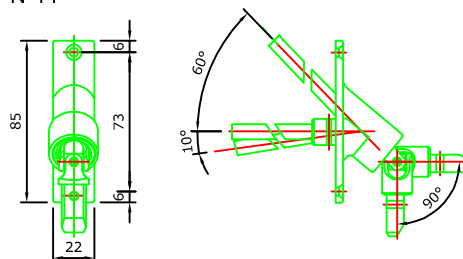

N°14 = 03 TR90/22/8/4Z

ECKWINKELDURCHFÜHRUNG PVC

Senkschrauben 4x20 mm Art. 16VISPA4/20 

N°16 / N°17

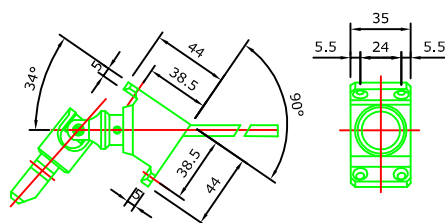

N°16 = 03TRANG8/4BL
N°17 = 03TRANG8/4GR

UNTERLAGPLATTEN NUR FÜR DURCHFÜHRUNG ZAMAC 90° - N°14

N°18

N°19

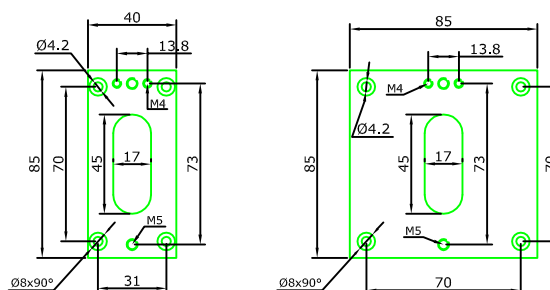

N°18 = 03PLA40/85

N°19 = 03PLA85/85

DURCHFÜHRUNG PVC

N°32 / N°33 Flachkopfschrauben 5 x 20 mm Art. 16VISPATB5/20 

N°36 / N°37 Flachkopfschrauben 4 x 20 mm Art. 16VISPATB4/20 

N°32 / N°33

N°36 / N°37

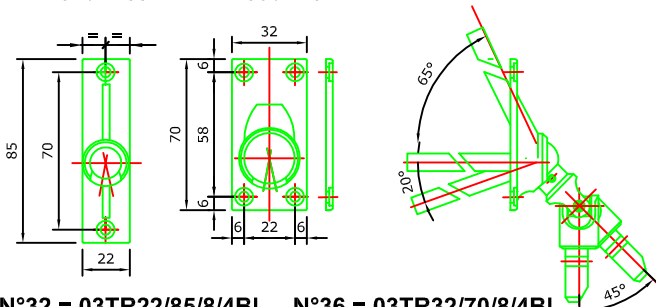

N°32 = 03TR22/85/8/4BL N°36 = 03TR32/70/8/4BL
N°33 = 03TR22/85/8/4GR N°37 = 03TR32/70/8/4GR

DURCHFÜHRUNG PVC (Zum Abkröpfen)

Flachkopfschrauben 3.5 x 20 mm Art. 16VISPATB3.5/20 

N°38 / N°39

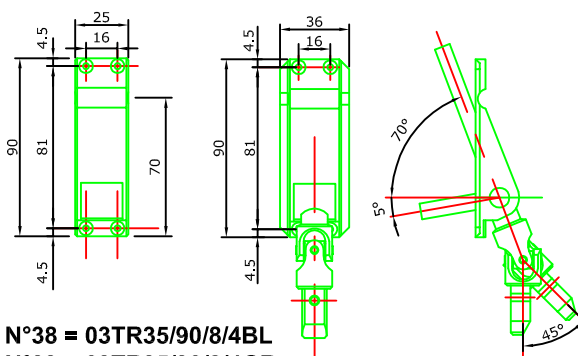

N°38 = 03TR35/90/8/4BL
N°39 = 03TR35/90/8/4GR

KURBEL

ZUBEHÖR ZU ALU-KURBELN

Kurbelhalter PVC

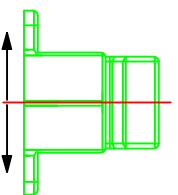
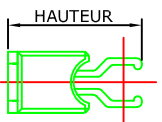

DIE HÖHE IST VON
33 BIS 53 MM IN
6 STUFEN
VERSTELLBAR.

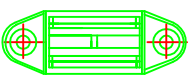

Art. 03PINBL
Art. 03PINGR

Kurbelstange

Senkschrauben 4x20 mm Art. 16VISPA4/20

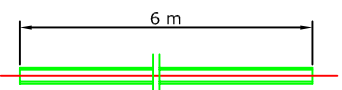

SICHERUNGSRINGE
FÜR DURCHFÜHRUNG

Art. 03ASBL
Art. 03ASGR

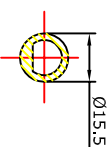

Art. 03TMALBL
Art. 03TMALGR

Kurbelgriff

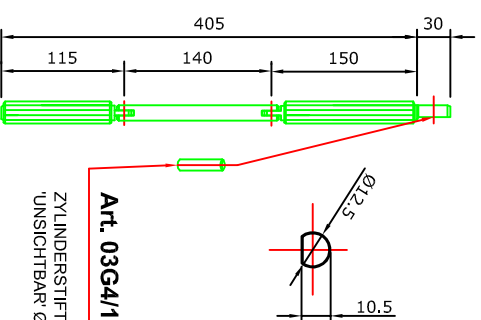

Art. 03G4/16.2
ZYLINDERSTIFT INOX
'UNSICHTBAR' Ø4x16.2

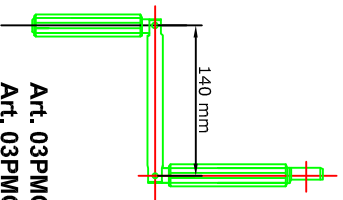

Art. 03PMGBL
Art. 03PMGGR

ZUBEHÖR ZU STAHL-KURBELN PVC UMMANTELT

Kurbelhalter MAGNET

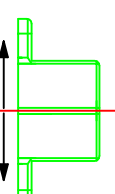
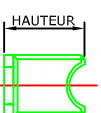

DIE HÖHE IST VON
23 BIS 43 MM IN
6 STUFEN
VERSTELLBAR.



Art. 03AMBL
Art. 03AMGR

Kurbelstange

Senkschrauben 4x20 mm Art. 16VISPA4/20

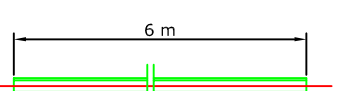

SICHERUNGSRINGE
FÜR DURCHFÜHRUNG

Art. 03TMBL
Art. 03TMGR

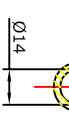

Art. 03TMBL
Art. 03TMGR

Kurbelgriff

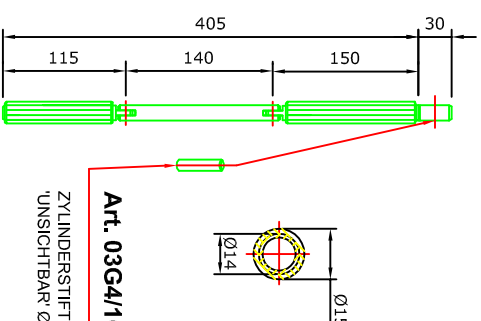

Art. 03G4/16.2
ZYLINDERSTIFT INOX
'UNSICHTBAR' Ø4x16.2

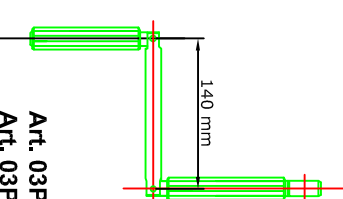

Art. 03PMBL
Art. 03PMGR

SPEZIALKURBELN

Kurbel Ausziehbar

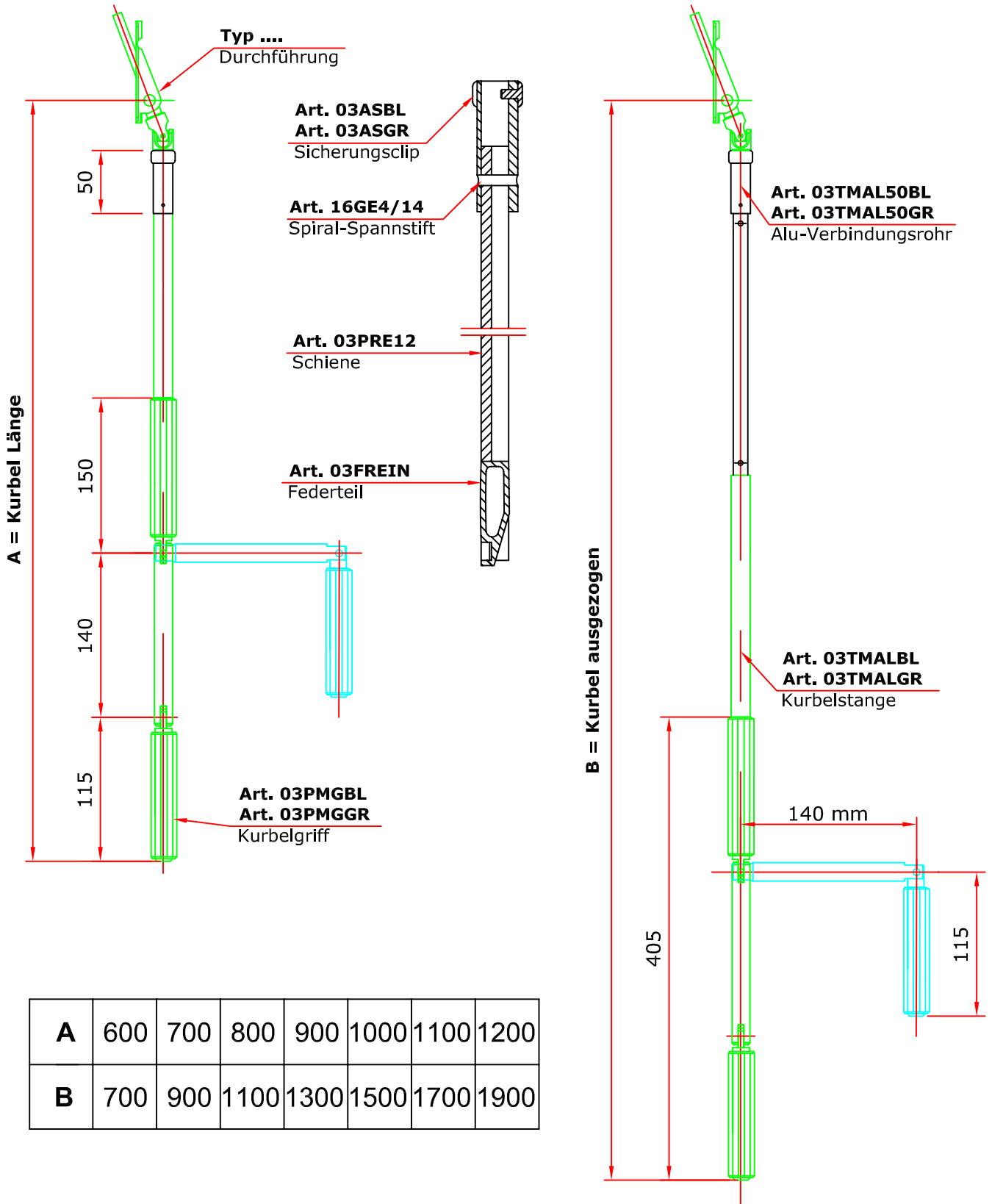

SPEZIALKURBELN

Kurbel zweiteilig

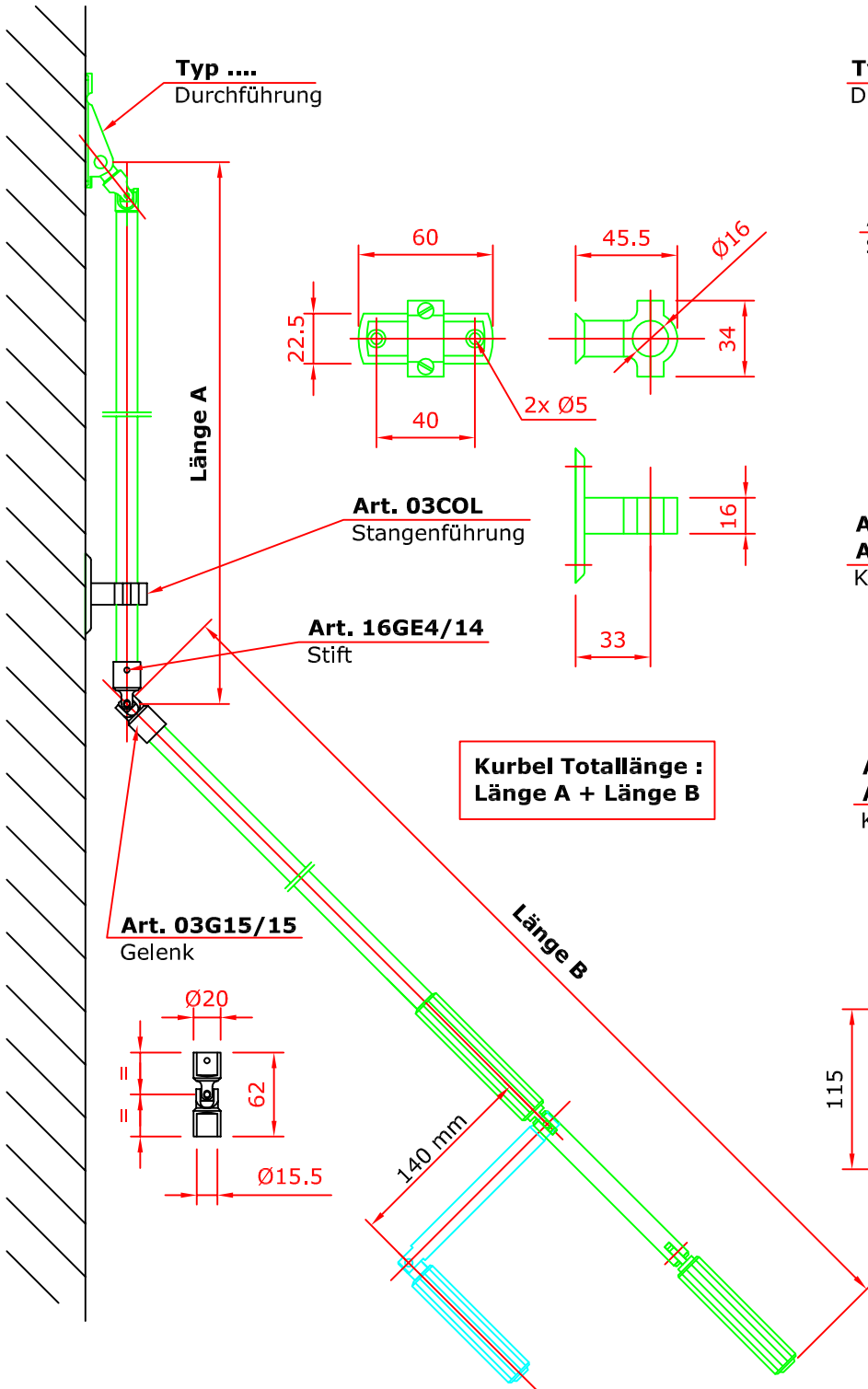

Kurbel mit Bajonett

