

KURBEL

ZUBEHÖR ZU ALU-KURBELN

Kurbelhalter PVC

Senkschrauben 4x20 mm Art. 16VISPA4/20

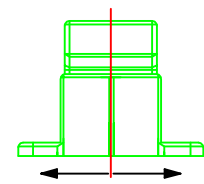
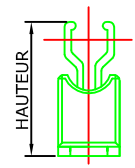

DIE HÖHE IST VON
33 BIS 53 MM IN
6 STUFEN
VERSTELLBAR.

Art. 03PINBL
Art. 03PINGR

Kurbelstange

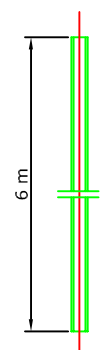

SICHERUNGSRINGE
FÜR DURCHFÜHRUNG

Art. 03ASBL
Art. 03ASGR

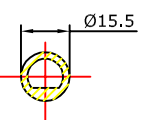

Art. 03TMALBL
Art. 03TMALGR

Kurbelgriff

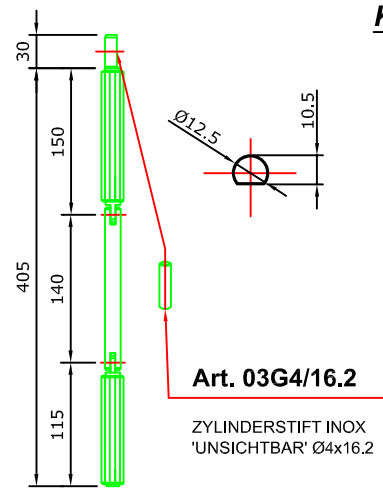

Art. 03G4/16.2

ZYLINDERSTIFT INOX
'UNSICHTBAR' Ø4x16.2

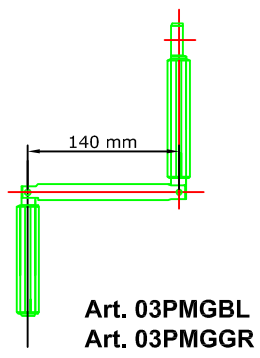

Art. 03PMGBL
Art. 03PMGGR

ZUBEHÖR ZU STAHL-KURBELN PVC UMMANTELT

Kurbelhalter MAGNET

Senkschrauben 4x20 mm Art. 16VISPA4/20

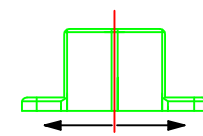
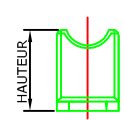

DIE HÖHE IST VON
23 BIS 43 MM IN
6 STUFEN
VERSTELLBAR.

Art. 03AMBL
Art. 03AMGR



Kurbelstange

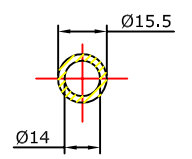
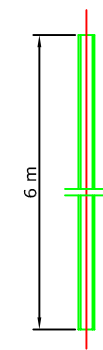

Art. 03TMBL
Art. 03TMGR

Kurbelgriff

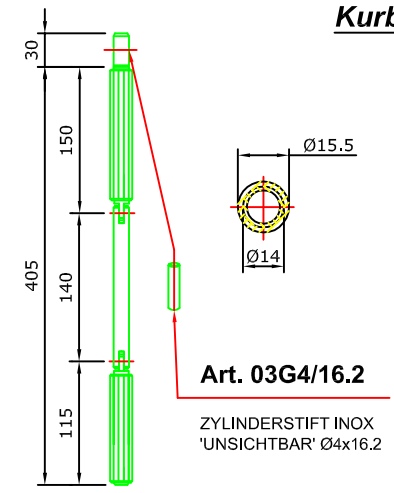

Art. 03G4/16.2

ZYLINDERSTIFT INOX
'UNSICHTBAR' Ø4x16.2

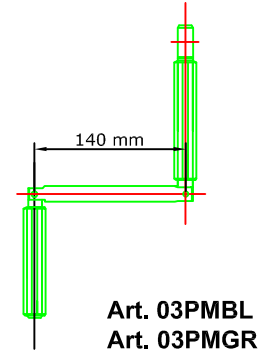

Art. 03PMBL
Art. 03PMGR