

TRANSMISSION POUR MONOBLOC

 = 4 pans / 8 mm / Longueur 500 mm (livrées sans les vis)
Pour engrenage N° 5 - 6 - 7 - 8

TRANSMISSION CARDAN INOX ENTAILLE

Vis à tête conique 4x20 mm Art. 16VISPA4/20 

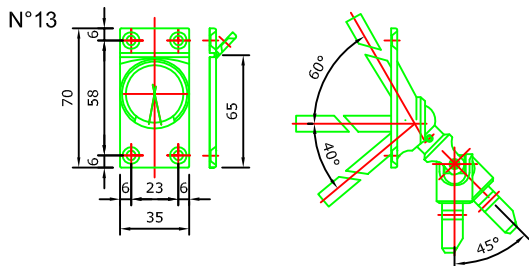

N°13 = 03TR35/70/8/4I (entaillée)

TRANSMISSION CARDAN D'ANGLE PVC

Vis à tête conique 4x20 mm Art. 16VISPA4/20 

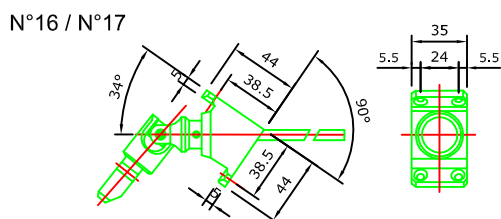

N°16 = 03TRANG8/4BL
N°17 = 03TRANG8/4GR

TRANSMISSION CARDAN PVC

N°32 / N°33 Vis à tête plate 5 x 20 mm Art. 16VISPATB5/20 

N°36 / N°37 Vis à tête plate 4 x 20 mm Art. 16VISPATB4/20 

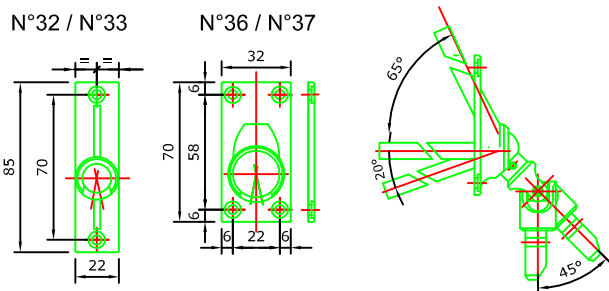

N°32 = 03TR22/85/8/4BL N°36 = 03TR32/70/8/4BL
N°33 = 03TR22/85/8/4GR N°37 = 03TR32/70/8/4GR

TRANSMISSION ZAMAC

Fixe sur caisson

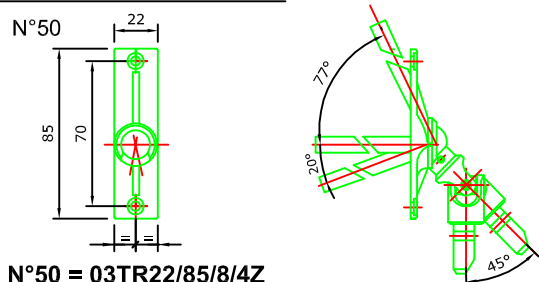

TRANSMISSION CARDAN ZAMAC 90°

Vis à tête conique 4x20 mm Art. 16VISPA4/20 

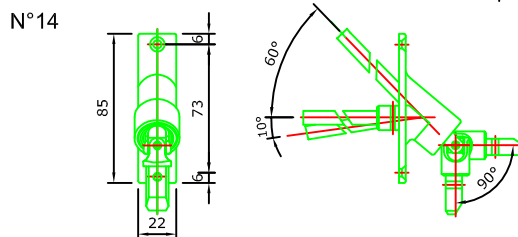

N°14 = 03 TR90/22/8/4Z

PLAQUE D'ADAPTATION POUR TRANSMISSION ZAMAC 90° - N°14

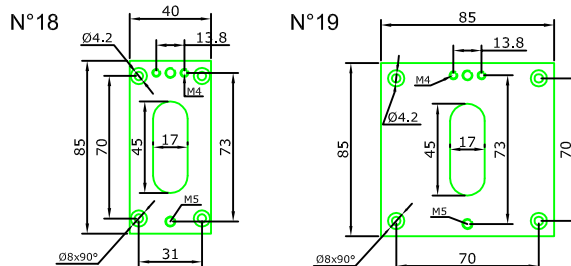

N°18 = 03PLA40/85

N°19 = 03PLA85/85

TRANSMISSION PVC (Flexible)

Vis à tête plate 3.5 x 20 mm Art. 16VISPATB3.5/20 

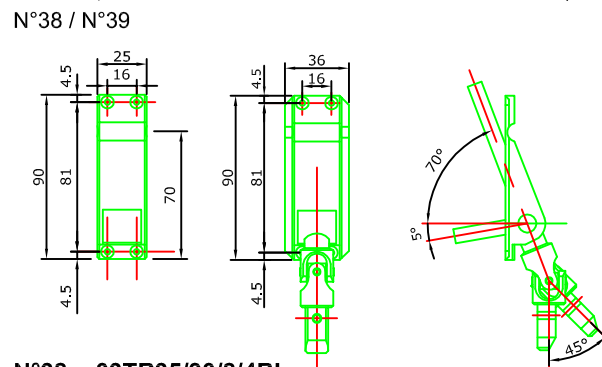

N°38 = 03TR35/90/8/4BL
N°39 = 03TR35/90/8/4GR

TRANSMISSION ZAMAC

Fixe sur caisson

